



GERBER

www.gerberonline.com

ULTRA FLUSH™ 1.28 GPF Elongated ErgoHeight™ Toilet

14" Rough-In

Features:

□ HE-21-324

- Vitreous china
- Recommended 35 PSI minimum operating pressure
- Sloan Flushmate pressure vessel
- 14" rough-in
- Pressurized flushing action
- Elongated ErgoHeight™ bowl
- Dual-fed siphon jet action bowl (no splashing)
- 2" fully glazed trapway for effective waste removal
- Front tank lever
- 6 point tank to bowl connection for tank stability
- Sanitary bead for easy cleaning
- Color matched bolt caps included
- Toilet seat not included



Technical Information:

Included Components:

- Combination HE-21-324
- Bowl HE-21-377
- Tank HE-28-384

Fixtures:

Configuration	two-piece, elongated Ergoheight™
Water per Flush	1.28 gpf (4.8 lpf)
Rough-In	14"
Height	31"
Width	20 5/8"
Depth	31 5/8"
Trapway	2"
Large Water Surface	10 1/8" x 8 5/8"
Shipping Weight	107 lbs

Accessories:

Soft Close Toilet Seat	99-213
------------------------	--------

Colors/Finishes:

- White

Warranty:

- 10 year warranty on Pressure Vessel, Limited Lifetime Warranty on Vitreous China

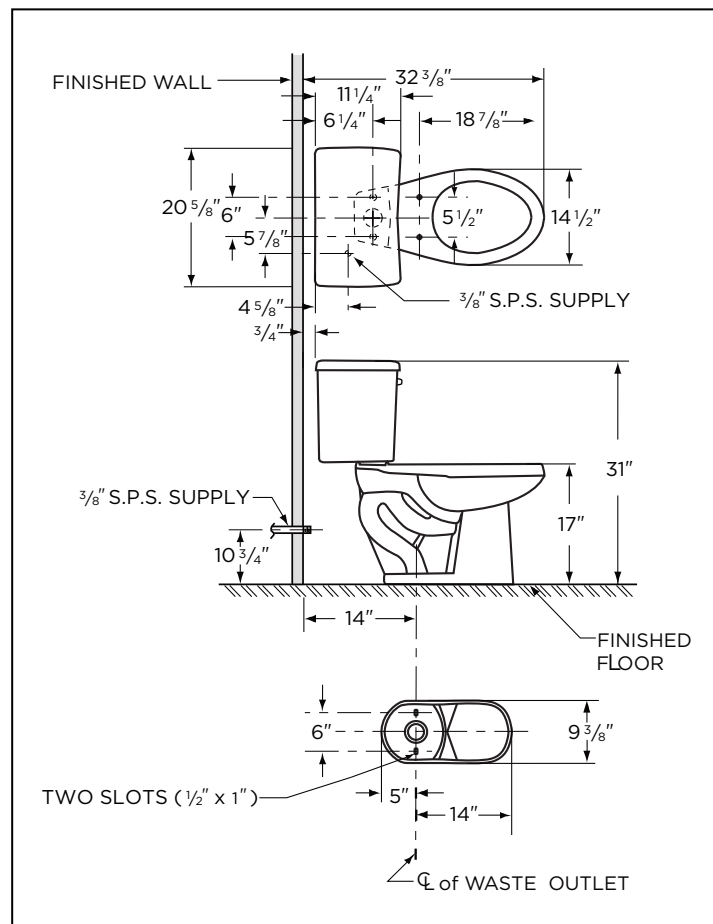

NOTES: All dimensions are in inches. Illustrations may not be drawn to scale.

IMPORTANT:

Dimensions of fixtures are nominal and may vary within the range of tolerances established by ASME standard A 112.19.2 THIS FIXTURE QUALIFIES ACCORDING TO ASME TEST PROCEDURES AS A HIGH EFFICIENCY WATER CLOSET WITH AN AVERAGE CONSUMPTION OF 1.28 gpf (4.8 Lpf) OR LESS.